



HEAVY DUTY VERTICAL MACHINING CENTER

Mynx

5400 II • 6500 II • 7500 II • 9500



DN SOLUTIONS

Mynx II series

5400 II · 6500 II · 7500 II · 9500

Mynx II series offers a wide line-up from 550 mm (21.7 inch) to 950 mm (37.4 inch) and various spindle enabling to meet the user to handle a wider range of workpieces. In addition, Mynx series offers high durability, high performance to designed high rigidity. The Ez work functions for the user-friendliness has improved the convenience of customers.



Mynx 7500 II





Mynx 6500 II



Mynx 5400 II

USERS CAN BE SELECTED ACCORDING TO MATERIAL AND SIZE OF WORKPIECE

- Wide line-up from 550mm (21.7 inch) to 950mm (37.4 inch) and various spindle are available to meet material and size of workpiece.

HIGH PRODUCTIVITY AND STABLE PRECISION, POWERFUL CUTTING PERFORMANCE

- High-rigidity machine structure provides high durability and stable accuracy during heavy duty cutting.
- Higher productivity can be achieved with the CAM-type tool changer that supports faster tool changing.

EASY OPERATION FOR IMPROVING CONVINIENCE TO USE NC SYSTEM

- Easy operation for user's convenient machine operation.
- The Ez work functions for the user-friendliness has improved the convenience of customers.

BASIC STRUCTURE

The Mynx II series offers a wide line-up. High-rigidity machine structure provides high durability and stable accuracy during heavy duty cutting.

Travel distance (X / Y / Z axis)

Mynx 5400 II, Mynx 5400/50 II

1020 / 550 / 530 mm
40.2 / 21.7 / 20.9 inch

Mynx 6500 II, Mynx 6500/50 II

1270 / 670 / 625 mm
50.0 / 26.4 / 24.6 inch

Mynx 7500 II, Mynx 7500/50 II

1525 / 770 / 625 mm
60.0 / 30.3 / 24.6 inch

Mynx 9500

2500 / 950 / 850 mm
98.4 / 37.4 / 33.5 inch



Mynx 5400 II, Mynx 6500 II

AXIS SYSTEM

Applied a highly rigid box guideway structure suitable for heavy cutting. The extended box-type guideways improve the machine durability as well as rigidity and stability.

Rapid traverser rate (X / Y / Z axis)

Mynx 5400 II, Mynx 5400/50 II

Mynx 6500 II, Mynx 6500/50 II

Mynx 7500 II, Mynx 7500/50 II

30 / 30 / 24 m/min
1181.1 / 1181.1 / 944.9 ipm

Mynx 9500

16 / 16 / 16 m/min
629.9 / 629.9 / 629.9 ipm



Surface Finish

The surface of moving elements are coated with Rulon 142 material to reduce friction and stick-slip. This material is carefully hand-scraped to achieve optimum accuracy.

SPINDLE

Users can select spindles of various driving systems and specifications according to the workpiece material.

Drive Systems

The Mynx II series spindles support Direct-driven, Belt-driven, Gear-driven, Built in-driven systems. Dual contact tool system support as standard.

Models	Taper	Standard	Optional
Mynx 5400 II *** Mynx 6500 II *** Mynx 7500 II ***	ISO #40	8000r/min (15/11 kW (20.1/14.8 Hp), 286.5 N·m (211.4 ft-lbs))	12000r/min (15.6 kW (20.9 Hp), 165.5 N·m (122.1 ft-lbs))
Mynx 5400/50 II Mynx 6500/50 II	ISO #50	6000r/min (15/11 kW (20.1/14.8 Hp), 286.4 N·m (211.4 ft-lbs))	6000r/min (18.5/15 kW (24.8/20.1 Hp), 307.2 N·m (226.7 ft-lbs))
			6000r/min* (30/18.5 kW (40.2/24.8 Hp), 617.4 N·m (455.6 ft-lbs))
			8000r/min (15/11 kW (20.1/14.8 Hp), 286.4 N·m (211.4 ft-lbs))
Mynx 7500/50 II	ISO #50	6000r/min (18.5/15 kW (24.8/20.1 Hp), 307.2 N·m (226.7 ft-lbs))	6000r/min (22/18.5 kW (29.5/24.8 Hp), 365.5 N·m (269.7 ft-lbs))
			6000r/min* (30/18.5 kW (40.2/24.8 Hp), 617.4 N·m (455.6 ft-lbs))
			8000r/min (15/11 kW (20.1/14.8 Hp), 286.4 N·m (211.4 ft-lbs))
Mynx 9500	ISO #50	6000r/min* (30/18.5 kW (40.2/24.8 Hp), 617.4 N·m (455.6 ft-lbs))	10000r/min** (30/25 kW (40.2/33.5 Hp), 420 N·m (310.0 ft-lbs))

None : Belt-driven * : Gear-driven ** : Built in-driven *** : Direct-driven



Mynx 9500 Gear-driven spindles



Dual Contact Spindle

The system enables simultaneous dual-contact of tapered side using elastic deformation of the spindle and perfect gauge control.

TABLE

Mynx II series offers an optimized table for machine line up enabling to meet the user to handle a wider range of workpieces.

Max weight on Table

Mynx 5400 II, Mynx 5400/50 II
1000 kg 2204.6 lb

Mynx 6500 II, Mynx 6500/50 II
1300 kg 2866.0 lb

Mynx 7500 II, Mynx 7500/50 II
1500 kg 3306.9 lb

Mynx 9500
3500 kg 7716.1 lb

Table size (A x B)

Mynx 5400 II, Mynx 5400/50 II
1200 x 540 mm 47.2 x 21.3 inch

Mynx 6500 II, Mynx 6500/50 II
1400 x 670 mm 55.1 x 26.4 inch

Mynx 7500 II, Mynx 7500/50 II
1600 x 750 mm 63.0 x 29.5 inch

Mynx 9500
2500 x 950 mm 98.4 x 37.4 inch

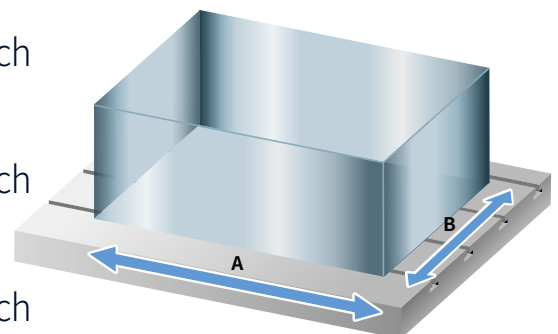

MACHINING PERFORMANCE

The heavy-duty machining performance of the Mynx II series spindles is the best in its class.

ISO #40

Result of cutting test on Mynx 5400 II (8000r/min, Direct, 15/11kW (20.1/14.8 Hp))

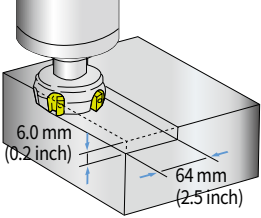
Face mill (ø80 mm, Cut edge count :6) Carbon steel (SM45C)			
Machining rate (cm ³ /min(in ³ /min))	Spindle speed (r/min)	Feedrate (mm/min (ipm))	
374.4 (22.8)	500	1950 (76.8)	

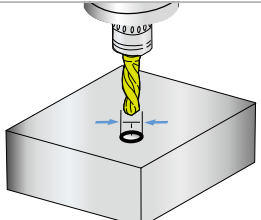
Drill (ø50 mm) Carbon steel (SM45C)			
Machining rate (cm ³ /min(in ³ /min))	Spindle speed (r/min)	Feedrate (mm/min (ipm))	
265.07 (16.2)	500	135 (5.3)	

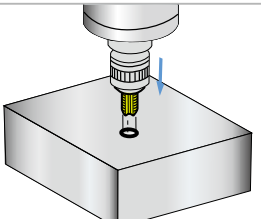
Tap Carbon steel (SM45C)			
Tap size (mm (inch))	Spindle speed (r/min)	Feedrate (mm/min (ipm))	
M36 x P4.0 (M1.4 x P0.2)	265	1060 (41.7)	

* The results, indicated in this catalogue are provides as example. They may not be obtained due to differences in cutting conditions and environmental conditions during measurement.

ISO #50

Result of cutting test on Mynx 9500 (6000r/min, Gear, 30/18.5kW (40.2/24.8 Hp))

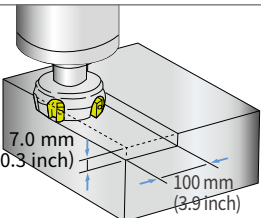
Face mill (ø125 mm,Cut edge count :8) Carbon steel (SM45C)			
Machining rate (cm ³ /min(in ³ /min))	Spindle speed (r/min)	Feedrate (mm/min (ipm))	
756 (46.1)	464	1080 (42.5)	

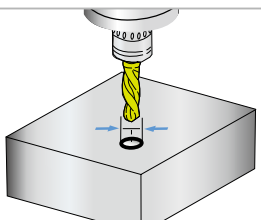
Drill (ø85 mm) Carbon steel (SM45C)			
Machining rate (cm ³ /min(in ³ /min))	Spindle speed (r/min)	Feedrate (mm/min (ipm))	
510 (31.1)	562	90 (3.5)	

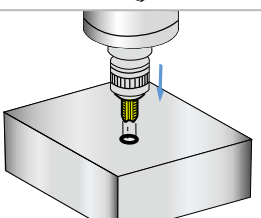
Tap Carbon steel (SM45C)			
Tap size (mm (inch))	Spindle speed (r/min)	Feedrate (mm/min (ipm))	
M42 x P4.5 (M1.7 x P0.2)	100	450 (17.7)	

* The results, indicated in this catalogue are provides as example. They may not be obtained due to differences in cutting conditions and environmental conditions during measurement.

TOOL CHANGER

Higher productivity can be achieved with the CAM-type tool changer that supports faster tool changing.



Chain type CAM magazine



Drum-type CAM magazine

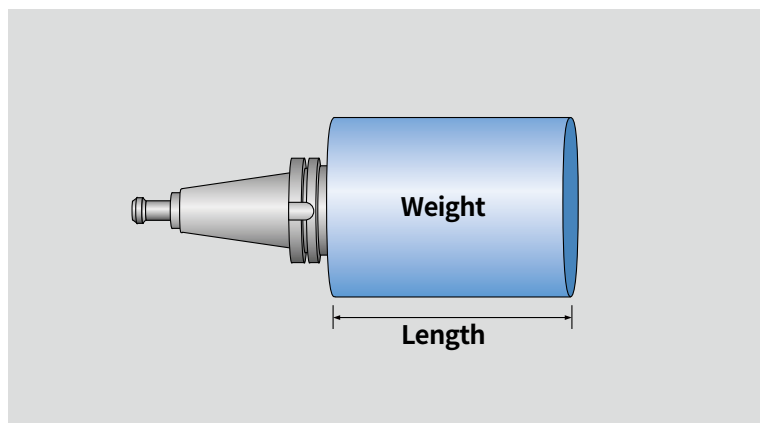

Automatic tool changer

Tool storage capacity

Mynx 5400 II, Mynx 6500 II, Mynx 7500 II

30 ea

40 ea option

Mynx 5400/50 II

24 ea

Mynx 6500/50 II

24 ea

30 ea* option

Mynx 7500/50 II

24 ea

40 ea* option

Mynx 9500

30 ea*

40 ea* option

None : Drum-type CAM magazine * : Chain type CAM magazine (Servo type)

Taper

Mynx 5400 II, Mynx 6500 II, Mynx 7500 II

ISO #40

Mynx 5400/50 II, Mynx 6500/50 II

Mynx 8500/50 II, Mynx 9500

ISO #50

Automatic tool changer

Models	Taper	Tool Change Time		Max. Tool Size	
		T-T-T	C-T-C	Length	Weight
Mynx 5400 II	ISO #40	1.3 s	3.7 s	300mm (11.8 inch)	8kg (17.6 lb)
Mynx 6500 II					
Mynx 7500 II					
Mynx 5400/50 II	ISO #50	2.5 s	5.5 s	350mm (13.8 inch)	20kg (33.1 lb)
Mynx 6500/50 II					
Mynx 7500/50 II					
Mynx 9500					

STANDARD | OPTIONAL SPECIFICATIONS

A range of options is available to suit individual requirements.

Description	Features			Mynx 5400 II	Mynx 5400/50 II	Mynx 6500 II	Mynx 6500/50 II	Mynx 7500 II	Mynx 7500/50 II	Mynx 9500
				Mynx 5400 II	Mynx 5400/50 II	Mynx 6500 II	Mynx 6500/50 II	Mynx 7500 II	Mynx 7500/50 II	Mynx 9500
				SIEMENS	SIEMENS	SIEMENS	SIEMENS	SIEMENS	SIEMENS	SIEMENS
Spindle	6000 r/min	Belt**	15/11 kW	X	●	X	●	X	X	X
			18.5/15 kW	X	○	X	○	X	●	X
		22/18.5 kW	X	X	X	X	X	○	X	
	8000 r/min	Gear*	30/18.5 kW	X	○	X	○	X	○	●
			15/11 kW	●	X	●	X	●	X	X
	10000 r/min	Built in*	15/11 kW	X	○	X	○	X	○	X
15.6 kW			X	X	X	X	X	X	○	
12000 r/min	Direct*	15.6/15.6 kW	○	X	○	X	○	X	X	
Spindle cooling system(Oil cooler)	6000 r/min	Belt*	15/11 kW	X	○	X	○	X	○	X
			18.5/15 kW	X	●	X	●	X	●	●
	8000 r/min	Direct*	15/11 kW	○	X	○	X	○	X	X
			18.5/15 kW	X	●	X	●	X	●	X
10000 r/min	Built in*	15/11 kW	X	X	X	X	X	X	●	
		15.6 kW	●	X	●	X	●	X	X	
Magazine	Tool storage capacity	24ea	X	●	X	●	X	●	X	
		30ea	●	X	●	○	●	X	●	
		40ea	○	X	○	X	○	○	○	
Tool shank type	ISO #40	BIG PLUS BT40	●	X	●	X	●	X	X	
		BIG PLUS CAT40	○	X	○	X	○	X	X	
		BIG PLUS DIN40	○	X	○	X	○	X	X	
	ISO #50	BIG PLUS BT50	X	●	X	●	X	●	●	
		BIG PLUS CAT50	X	○	X	○	X	○	○	
		BIG PLUS DIN50	X	○	X	○	X	○	○	
Coolant	FLOOD	0.15 MPa (0.4 kW)	●	●	●	●	●	●	●	
		0.7 MPa (1.8 kW)	○	○	○	○	○	○	○	
		None	●	●	●	●	●	●	●	
	TSC	2 MPa (1.5kW)	○	○	○	○	○	○	○	
		2 MPa (4.0 kW)	○	○	○	○	○	○	○	
		7 MPa (5.5 kW)	○	○	○	○	○	○	○	
		SHOWER	0.1 MPa (1.1 kW)	○	○	○	○	○	○	
	Oil Skimmer	Belt type	○	○	○	○	○	○		
	MQL		○	○	○	○	○	○		
	Chip disposal	Chip pan		●	●	●	●	●	●	
Chip conveyor			TYPE	HINGED PLATE	○	○	○	○	○	
			MAGNETIC SCRAPER	○	○	○	○	○		
		OUTLET DIRECTION	RIGHT SIDE/LEFT SIDE	○	○	○	○	○		
Chip bucket	CAPACITY	220 / 300 / 380	○	○	○	○	○	○		
	TYPE	ROTATION / FORKLIFT	○	○	○	○	○	○		
Precision machining option	Smart Thermal Compensation		●	●	●	●	●	●		
	Linear scale	X / Y / Zaxis	○	○	○	○	○	○		
	AICC II (200 block)		●	●	●	●	●	●		
Measurement & Automation	Automatic tool measurement	TS27R	○	○	○	○	○	○		
		OTS	○	○	○	○	○	○		
	Automatic tool breakage detection		○	○	○	○	○	○		
	Automatic workpiece measurement	OMP60	○	○	○	○	○	○		
Automatic front door with safety device		○	○	○	○	○	○			
Accessories	WORK LIGHT	LED LAMP	●	●	●	●	●	●		
	OPERATOR CALL LAMP	3-COLOR SIGNAL TOWER(LED)	●	●	●	●	●	●		
	SMART THERMAL CONTROL	SENSORLESS TYPE (ONLY SPINDLE)	●	●	●	●	●	●		
	ASSEMBLY & OPERATION TOOLS KIT		●	●	●	●	●	●		
	AIR BLOWER		○	○	○	○	○	○		
	4TH AXIS PREPARATION CABLING FOR SERVO/1-PNEUMATIC PIPING	FACTORY READY MADE	○	○	○	○	○	○		
	AIR GUN		○	○	○	○	○	○		
	Coolant gun		○	○	○	○	○	○		
	Mist collector		○	○	○	○	○	○		
	ANCHORING ⁽¹⁾		○	○	○	○	○	○		
Customized special option	COOLANT CHILLER ⁽²⁾		○	○	○	○	○	○		
	TSA ⁽³⁾	0.54 MPa	○	○	○	○	○	○		
	FEEDBACK SYSTEM	HEIDENHAIN	○	○	○	○	○	○		
	RAISING BLOCK	150 / 200 / 300 mm	○	○	○	○	○	○		
	SIDE AUTO DOOR	680 X 1000 (W X H) SET	○	○	○	○	○	○		
	AWC	8PALLET	○	○	○	○	○	○		
	AUTO TOOL LENGTH MEASUREMMENT	RENISHAW / LTS	○	○	○	○	○	○		
	AUTO TOOL BREAKAGE DETECTION	MSC/BK9(NEEDLE TYPE ON MAGAZINE)	○	○	○	○	○	○		

* Please contact DN Solutions to select detail specifications.

● Standard ○ Optional x Not applicable

(1) Please refer to foundation drawing in relation to anchoring. If more detail information want, consult with DN Solutions service

(2) In case of using neat cutting oil, this device is highly recommended in order to reduce the change of accuracy by rising the coolant temperatures.

(3) In case of TSC is not required and only TSA is needed, this option can be selected.

*Spindle cooling system (Oil cooler) is standard **Spindle cooling system (Oil cooler) is option ***Sensorless type (only Spindle) (Mynx 5400~7500II)

****When using a semi-synthetic type or synthetic type, contact our sales representative or service center in advance.

PERIPHERAL EQUIPMENT

Linear Scale option

Using the linear scale feedback system, accuracy of the machine can be further improved since the X, Y and Z axes can be controlled to correct positions.

Resolution : 0.001 mm



Smart thermal compensation (Mynx 9500 only)

Smart thermal compensation function fitted as standard optimizes machine accuracy of the spindle and structure by reducing the effects of heat build-up during extended periods of operation.

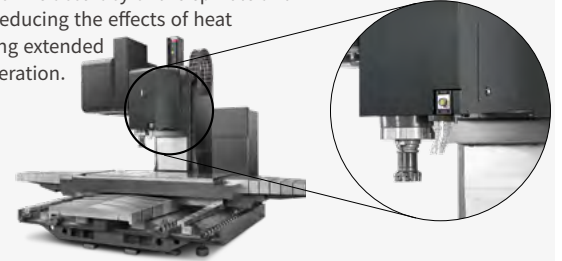

Chip conveyor option

Hinged type

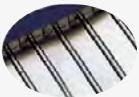

Magnetic scraper type



Drum filter type



Chip conveyor type	Material	Description
Hinged type	Steel	Hinged belt chip conveyor, which is most commonly used for steel work [for cleaning chips longer than 30mm(1.2inch)], is available as an option.
Magnetic scraper type	Cast Iron	Magnetic scraper type chip conveyor, which is ideal for die-casting work [for cleaning small chips], is available as an option.
Drum filter type	Aluminium	Drum filter type chip conveyor, which is ideal for aluminium work [for filtering small chips], is available as an option.

Oil Cooler option

An oil cooler correlated to room temperature can be equipped for a long-term operation at high speed. Cooling oil circulates around the spindle bearings to prevent thermal error of the spindle and maintain machining accuracy.



4th axis auxiliary device interface option

Users who wish to set up a rotary axis on the table to increase application flexibility are encouraged to contact DN Solutions in advance.

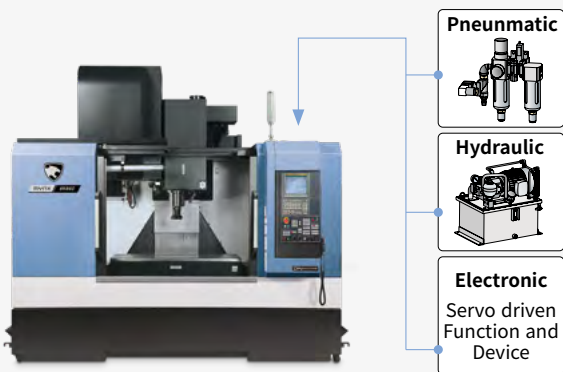

Hydraulic / Pneumatic fixture line option

The user should prepare pipelines for hydraulic / pneumatic fixtures whose detailed specifications should be determined by discussion with DN Solutions.

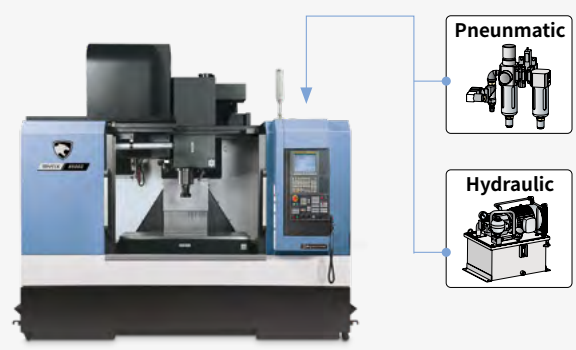

AWC system option

The optimized solution to realize compact automation system through automatic work-piece change system.



Max. workpiece dimensions	Unit	Count	Max. loading	Max. construction height on the pallet
250 x 250 (9.8x9.8) or ø 300 (11.8)	mm (inch)	12	130kg (286.6lb) 250kg (551.1lb)	350mm (13.8inch)
320 x 320 (12.6x12.6) or ø 360 (14.2)	mm (inch)	10		
350 x 350 (13.8x13.8) or ø 400 (15.7)	mm (inch)	8		
400 x 400 (15.7x15.7) or ø 450 (17.7)	mm (inch)	6		
500 x 500 (19.7x19.7) or ø 550 (21.7)	mm (inch)	4		

Pallet Storage-Table Configuration

Unit : mm (inch)

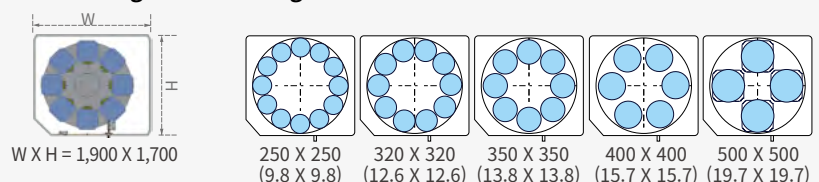

DN SOLUTIONS FANUC i PLUS

DN Solutions Fanuc i Plus is optimized for maximizing customer productivity and convenience.

15 inch screen + new operation panel

DN Solutions Fanuc i Plus' operation panel enhances operating convenience by incorporating common-design buttons and layout, and features the Qwerty keyboard for fast and easy operation.

DN Solutions Fanuc i Plus

- 15 inch color display
- Intuitive and user-friendly design

USB & PCMCIA card

QWERTY keyboard

- EZ-guide i standard
- Ergonomic operator panel
- 2MB Memory
- Hot key



iHMI touchscreen option

iHMI provides an intuitive interface that uses a touchscreen for quick and easy operation.

Range of applications

Providing various applications related to planning, machining, improvement and utility, for customer convenience.

NUMERIC CONTROL SPECIFICATIONS

FANUC

Item	Specifications	DN Solutions Fanuc i (0i Plus) Mynx 4digit	
Controlled axis	Controlled axes	3 (X,Y,Z)	
	Simultaneously controlled axes	4 axes	
	Additional controlled Axis	●	
Data input/output	Fast data server	○	
	Memory card input/output	●	
	USB memory input/output	●	
	Large capacity memory(2GB)*2	○	
Interface function	Available Option only with 15" Touch LCD (iHMI Only) *2	○	
	Embedded Ethernet	●	
	Fast Ethernet	○	
Operation	Enhanced Embedded Ethernet function	●	
	DNC operation	Included in RS232C interface.	
	DNC operation with memory card	●	
Program input	Workpiece coordinate system	G52 - G59	
	Addition of workpiece coordinate system	G54.1 P1 X 48 (48 pairs)	
	Tool number command	●	
	Tilted working plane indexing command	G68.2 TWP	
Feed function		T4 digits	
	AI contour control I	G5.1 Q_, 40 Blocks	
	AI contour control II	G5.1 Q_, 200 Blocks	
	AI contour control II	G5.1 Q_, 600 Blocks	
	AI contour control II	G5.1 Q_, 1000 Blocks *1)	
Operation guidance function	High smooth TCP	X	
	EZ Guidei (Conversational Programming Solution)	●	
	iHMI with Machining Cycle	Only with 15" Touch LCD standard *2)	
Setting and display	EZ Operation package	X	
	CNC screen dual display function	●	
Network	FANUC MTConnect	●	
	FANUC OPC UA	●	
Others	Display unit	10.4" color LCD	
		15" color LCD	
		15" color LCD with Touch Panel	
	Part program storage size & Number of registerable programs	640M(256KB)_ 500 programs	X
		1280M(512KB)_ 1000 programs	X
		2560M(1MB)_ 1000 programs	X
		5120M(2MB)_ 1000 programs	●
		10240M(4MB)_ 1000 programs	X
		20480M(8MB)_ 1000 programs	X
		2560M(1MB)_ 2000 programs	X
		5120M(2MB)_ 4000 programs	X
		10240M(4MB)_ 4000 programs	X
		20480M(8MB)_ 4000 programs	X
		X	

*1) The number of look-ahead blocks may be changed or limited depending on the peripheral device or the configuration of the internal NC system.

*2) Available Option only with Fanuc i plus iHMI

● Standard ○ Optional X N/A ⊕ Available
Network: FANUC MT Connect and FANUC OPC UA available.

EZ WORK

The software developed by DN Solutions provides a range of different functions designed for fast, efficient and convenient operation.

EZ work

The EZ work package delivers speed and efficiency. This menu-driven innovation not only helps customers reduce setup times, but also simplifies common tasks and procedures, reducing the potential for errors. EZ work reduces operating time, protects machinery, enhances quality and speeds up maintenance interventions.



Thermal Compensation

A function to maintain high-precision machining quality by analyzing and correcting the amount of thermal displacement of a structure through a temperature sensor



M/G-Code List

Functional description of M code and G code



Tool Management

Function to manage tool information [Tool information / Tool No. / Tool condition (normal, large diameter, worn / damaged, used for the rst time, manual) / Tool name]

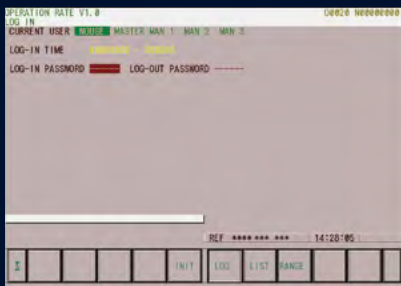

Operation Rate

Machine operation history management function by date based on load



Adaptive Feed Control

Function to control feedrate so that the cutting can be carried out at a constant load (To adapt to the spindle load set up with constant load feedrate control function)



Spindle Warm Up

A function that assists spindle warm-up for spindle life when the spindle has not been used for a certain period of time



ATC Recovery

Function to view detailed info with recommended actions and to perform step-by-step operation manually (when an alarm is triggered during an ATC operation)

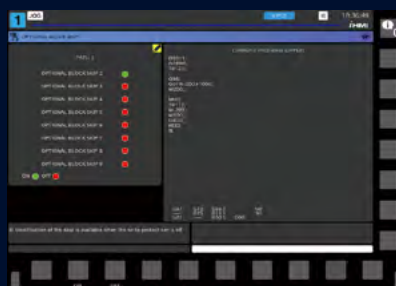

Addition of Optional Block Skip

In addition to the OPTIONAL BLOCK SKIP of the operation panel, the function to skip a specific block selected in the machining program

CONVENIENT OPERATION

HEIDENHAIN TNC620

Superior hardware specifications

The TNC 620 features optimized motion control, short block processing times and special control strategies. Together with its uniform digital design and its integrated digital drive control (including inverters), it enables you to achieve high machining speeds and the best possible contour accuracy.

- 15.6" display
- 21GB Storage memory
- 1024 look ahead blocks
- High user convenience with folder structure data management

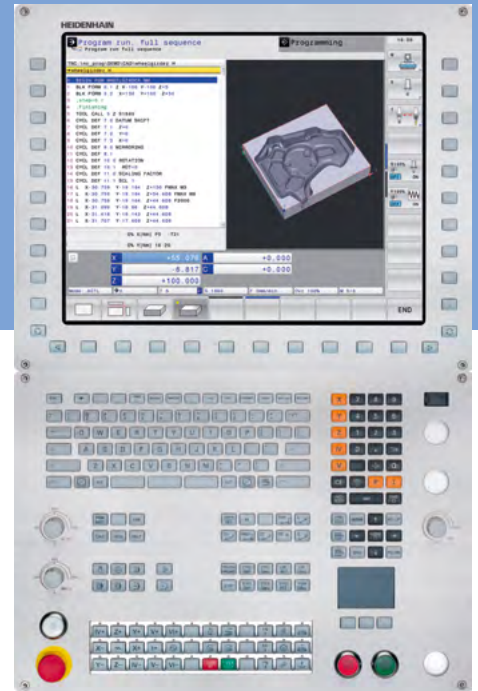

Conversational convenient function

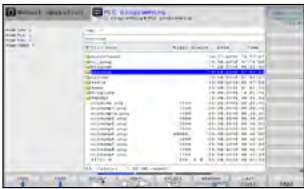

Data are controlled in the folder structure; convenient communication via USB devices



KinematicOpt & KinematicComp option
(Touch probe cycle for automatic measurement)

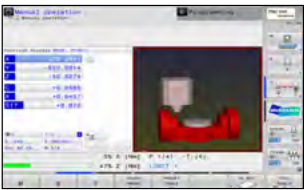

Collision protection system option

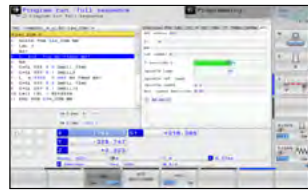

Adaptive feed control option



Various built-in pattern cycles for a wider scope of application (Software standard)

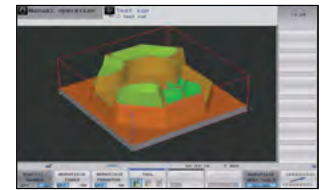

Graphic simulation

NUMERIC CONTROL SPECIFICATIONS



HEIDENHAIN

Item		Specifications	TNC620 Mynx series
Controlled axis	Controlled axis		3 (X,Y,Z)
	Simultaneously controlled axis		4 axis
Data input/output	USB memory input/output		●
Interface function	Embedded ethernet		●
Feed function	Look-ahead	5000 blocks	●
Axis compensation	KinematicsOpt	Automatic measurement and optimization of machine kinematics	○
Collision monitoring	Dynamic collision monitoring (DCM)		X
Network	MTConnect		⊕
Others	Display unit	15.1 inch TFT color flat panel	●
		15.1 inch TFT color with Touch Panel	○
		19 inch TFT color flat panel	○
		19 inch TFT color with Touch Panel	○
Part program storage size & number of registerable programs	21GB		X
	1.8GB		●

● Standard ○ Optional X Not Available ⊕ Available

CONVENIENT OPERATION

SIEMENS 828D

15.6" screen + new operation panel

The newly-designed operation panel improves the customer convenience by incorporating and using common-design buttons and layouts, and includes the familiar QWERTY keyboard for fast and easy operation.

- 15.6" display
- 10MB high capacity user memory
- USB & ethernet (standard)
- QWERTY keyboard (standard)
- High-speed calculation and simulation can be fulfilled by improved processor functionality



Conversational convenient function



Shop Mill Part Programming



Smart function

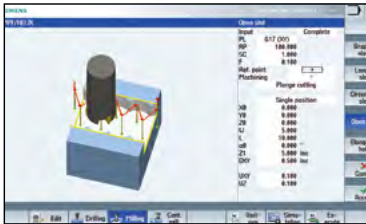

Advanced program language programGUIDE

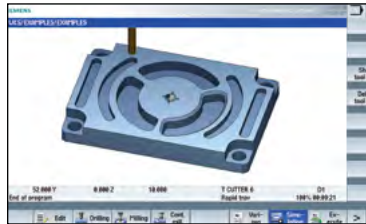

Simulation and machining contour monitoring

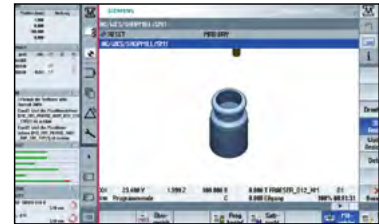

Side screen widget

NUMERIC CONTROL SPECIFICATIONS

SIEMENS

Item	Specifications	S840D	S828D
		Mynx	Mynx
Controlled axis	Controlled axes	3 axis	3 axis
	Simultaneously controlled axes	3 axis	3 axis
Data input/output	Memory card input/output	●	X
	USB memory input/output	●	X
Interface function	Ethernet (X130)	●	●
Operation	On network drive (without EES option, Extcall)	●	○
	On USB storage medium, e.g. memory stick (without EES option, Extcall)	●	●
Program input	Workpiece coordinate system G54 - G57	●	●
	Addition of workpiece coordinate system G505 - G599	●	●
Interpolation & Feed function	Advanced surface	●	●
	Top surface	○	○
Programming & Editing function	Look ahead number of block	1000	450
	3D simulation, finished part	●	●
	Simultaneous recording	●	●
	Measure kinematics	X	X
Operation Guidance Function	DXF Reader for PC integrated in SINUMERIK Operate	○	○
	ShopMill	●	●
Setting and display	EZ Work	●	●
	Operation via a VNC viewer	●	●
Network	MTConnect	⊕	⊕
	OPCUA	○	○
Etc. function	15.6" color display with touch screen	●	●
	19" color display without touch screen	○	X
	21.5" color display with touch screen	○	X
	CNC user memory	●	●
	Expansion by increments	○	○
	Collision avoidance	○	X
Collision avoidance ECO (machine, working area)	○	X	

● Standard ○ Optional X Not Available ⊕ Available

POWER | TORQUE

FANUC

Mynx 5400 II , Mynx 6500 II , Mynx 7500 II

8000 r/min, Direct

Motor power : 15/11 kW (20.1/14.8 Hp)
Torque : 286.5 N·m (211.4 ft-lbs)

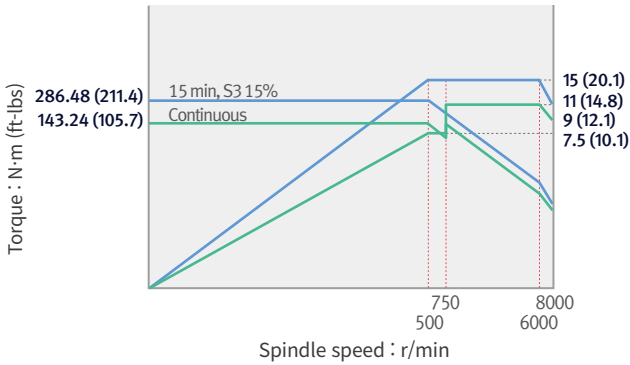

12000 r/min, Direct option

Motor power : 15.6 kW (20.9 Hp)
Torque : 165.5 N·m (122.1 ft-lbs)

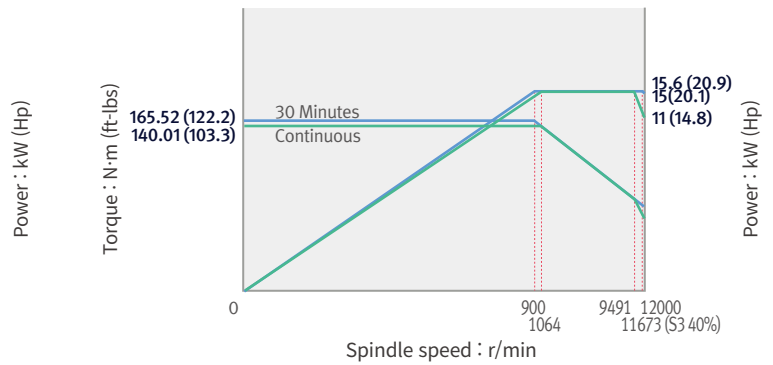

Mynx 5400/50 II , Mynx 6500/50 II

6000 r/min, Belt

Motor power : 15/11 kW (20.1/14.8 Hp)
Torque : 286.4 N·m (211.4 ft-lbs)

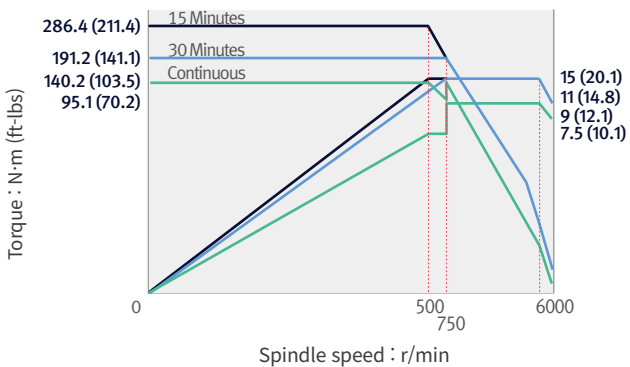

6000 r/min, Belt option

Motor power : 18.5/15 kW (24.8/20.1 Hp)
Torque : 307.2 N·m (226.7 ft-lbs)

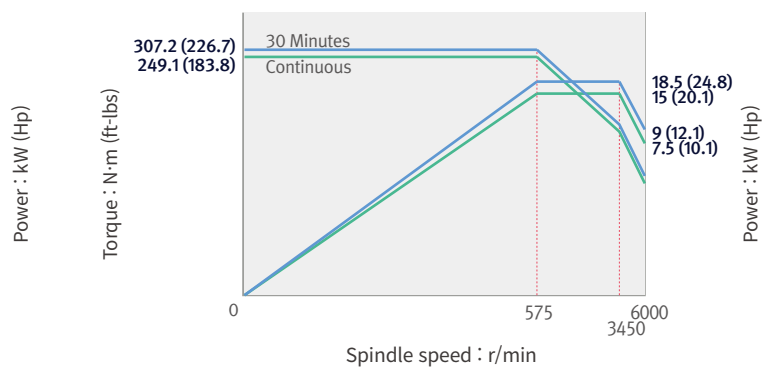

6000 r/min, Gear option

Motor power : 30/18.5 kW (40.2/24.8 Hp)
Torque : 617.4 N·m (455.6 ft-lbs)

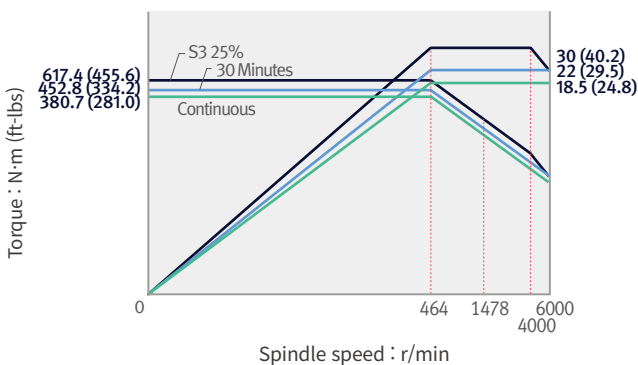

8000 r/min, Belt option

Motor power : 15/11 kW (20.1/14.8 Hp)
Torque : 286.4 N·m (211.4 ft-lbs)

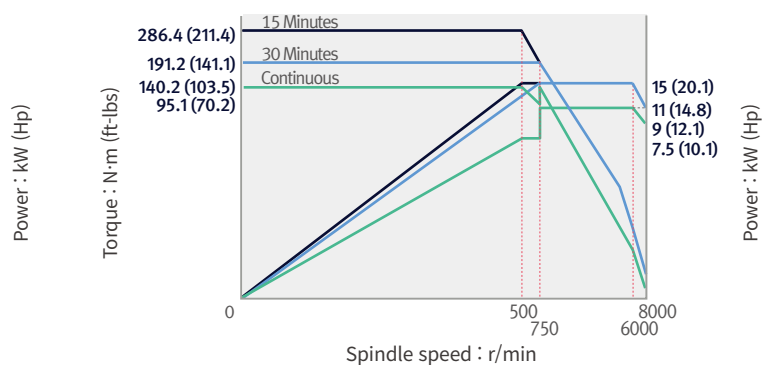

POWER | TORQUE

FANUC

Mynx 7500/50 II

6000 r/min, Belt

Motor power : 18.5/15 kW (24.8/20.1 Hp)
Torque : 307.2 N·m (226.7 ft-lbs)

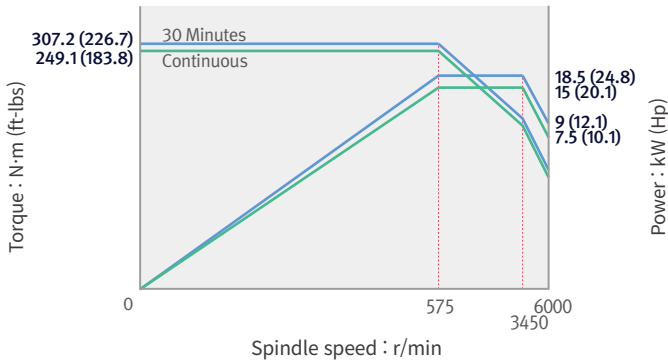

6000 r/min, Belt option

Motor power : 22/18.5 kW (29.5/24.8 Hp)
Torque : 365.5 N·m (269.7 ft-lbs)

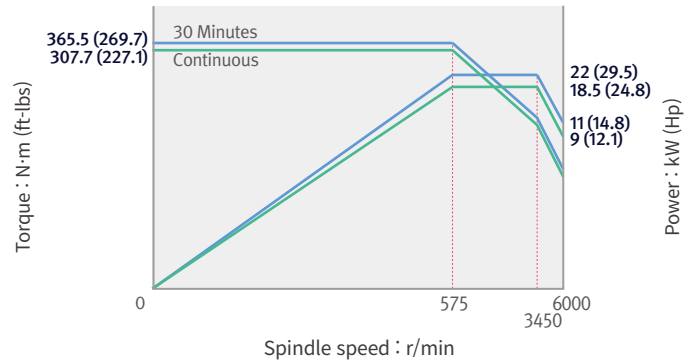

6000 r/min, Gear option

Motor power : 30/18.5 kW (40.2/24.8 Hp)
Torque : 617.4 N·m (455.6 ft-lbs)

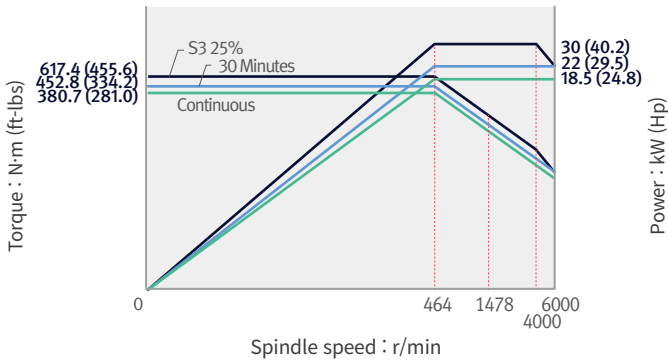

8000 r/min, Belt option

Motor power : 15/11 kW (20.1/14.8 Hp)
Torque : 286.4 N·m (211.4 ft-lbs)

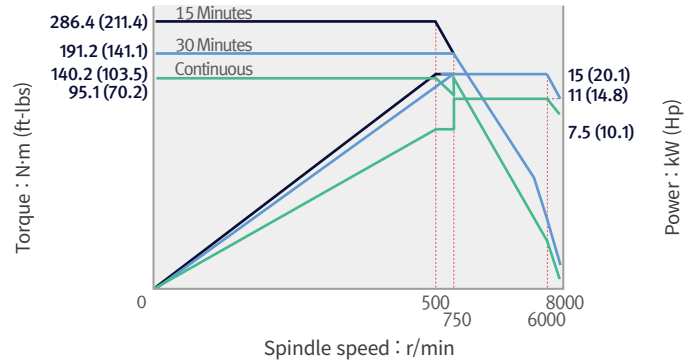

Mynx 9500

6000 r/min, Gear

Motor power : 30/18.5 kW (40.2/24.8 Hp)
Torque : 617.4 N·m (455.6 ft-lbs)

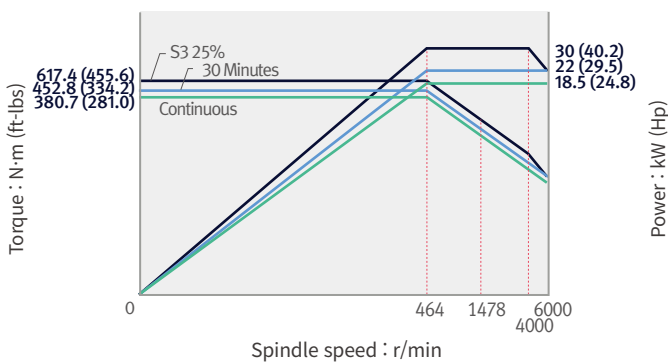

10000 r/min, Built in option

Motor power : 30/25 kW (40.2/33.5 Hp)
Torque : 420 N·m (310.0 ft-lbs)

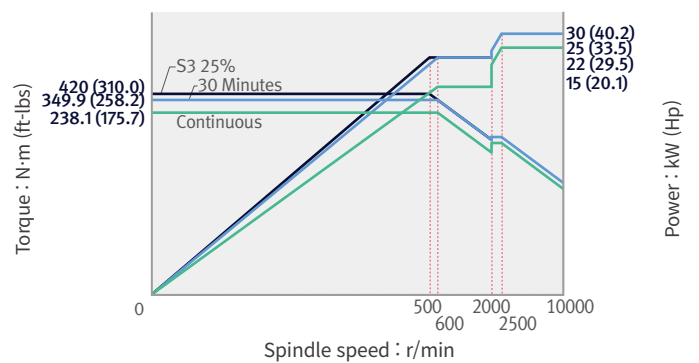

POWER | TORQUE

SIEMENS

12000 r/min, Direct

Motor power : 27.8 /18.5 kW (37.3/24.8 Hp)

Torque : 234.0 N·m (172.7 ft-lbs)

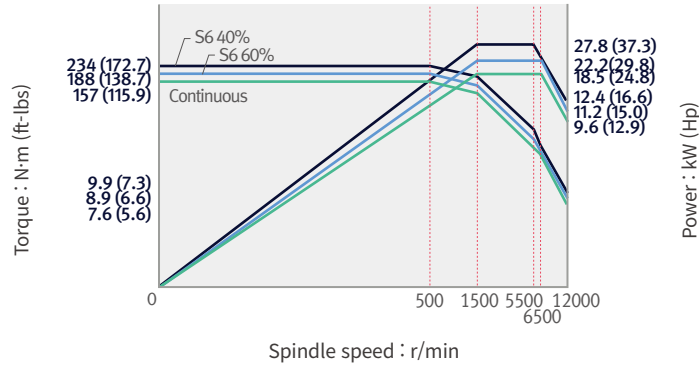

6000 r/min, Gear

Motor power : 27.8 /18.5 kW (37.3/24.8 Hp)

Torque : 760.0 N·m (560.9 ft-lbs)

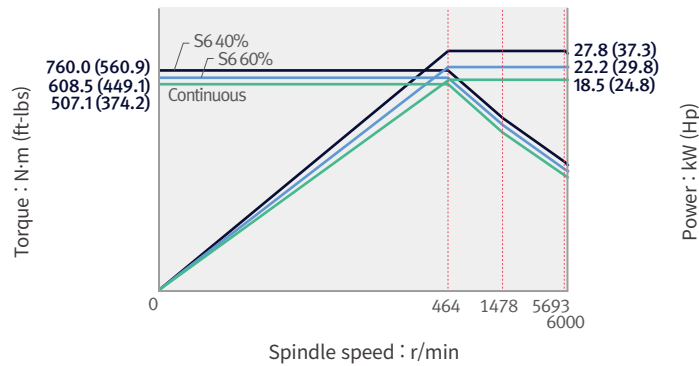

8000 r/min, Belt

Motor power : 27.8 /18.5 kW (37.3/24.8 Hp)

Torque : 234.0 N·m (172.7 ft-lbs)

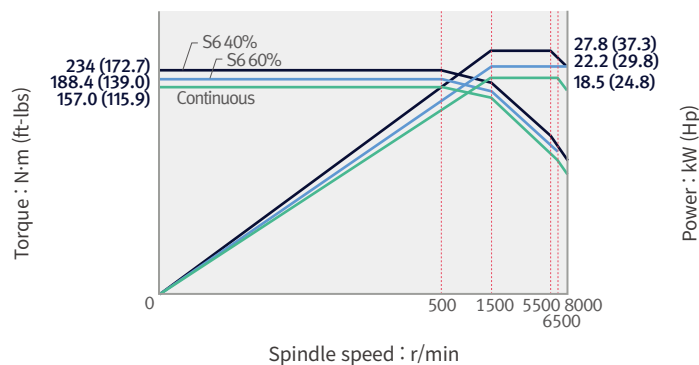

DIMENSIONS

Units : mm (inch)

TOP

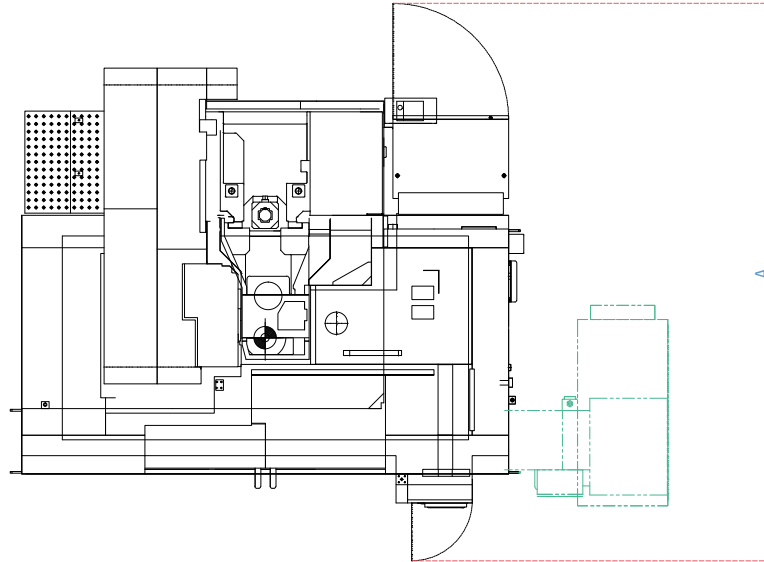

FRONT

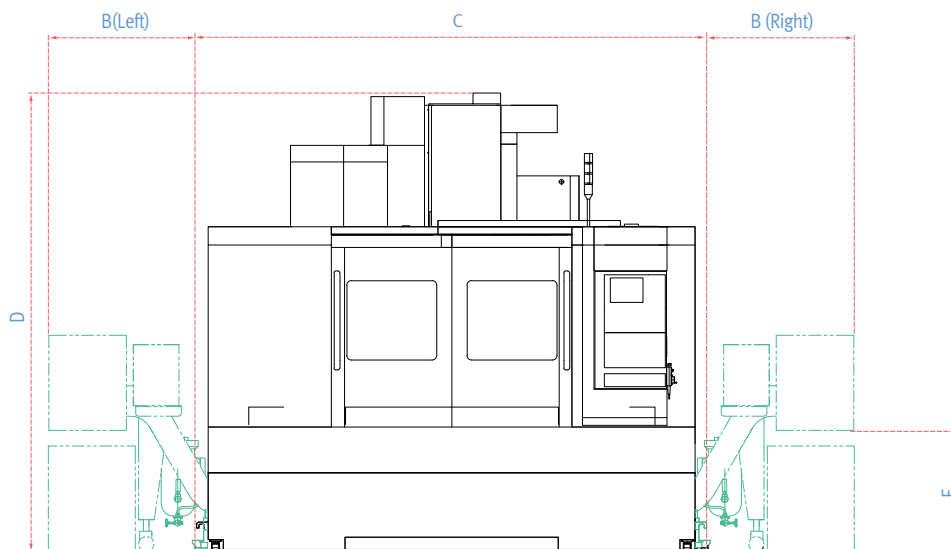

	A (Max. machine length)	B* (Additional width to accommodate the side chip conveyor)	C (Max. machine width)	D (Max. machine height)	E (Height from the floor to the chip outlet)
Mynx 5400 II	3450 (135.8)	Left & Right : 930 (36.6)	3350 (131.9)	3020 (118.9)	830 (32.7)
Mynx 5400/50 II	3450 (135.8)	Left & Right : 930 (36.6)	3350 (131.9)	2920 (115.0)	830 (32.7)
Mynx 6500 II	3670 (144.5)	Left & Right : 930 (36.6)	3350 (131.9)	3110 (122.4)	830 (32.7)
Mynx 6500/50 II	3670 (144.5)	Left & Right : 930 (36.6)	3350 (131.9)	3020 (118.9)	830 (32.7)
Mynx 7500 II	4410 (173.6)	Left & Right : 1060 (41.7)	3900 (153.5)	3230 (127.2)	980 (38.6)
Mynx 7500/50 II	4680 (184.3)	Left & Right : 1060 (41.7)	4050 (159.4)	3300 (129.9)	980 (38.6)
Mynx 9500	5350 (210.6)	Left & Right : 1170 (46.1)	6560 (258.3)	3600 (141.7)	770 (30.3)

* Contact DN Solutions for more information to rear chip conveyor.

* Some peripheral equipment can be placed in other places

TABLE DIMENSIONS

Mynx 5400 II, Mynx 5400/50 II

Units : mm (inch)

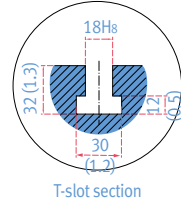
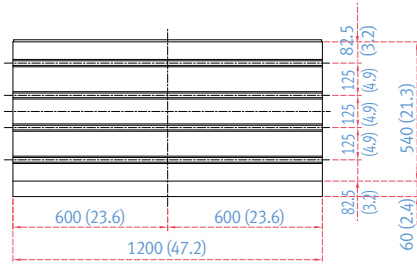

Mynx 6500 II, Mynx 6500/50 II

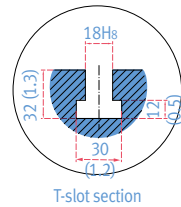
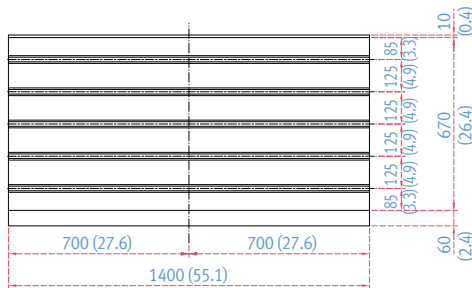

Mynx 7500 II Mynx 7500/50 II

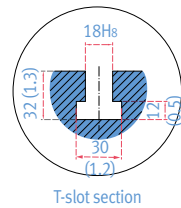
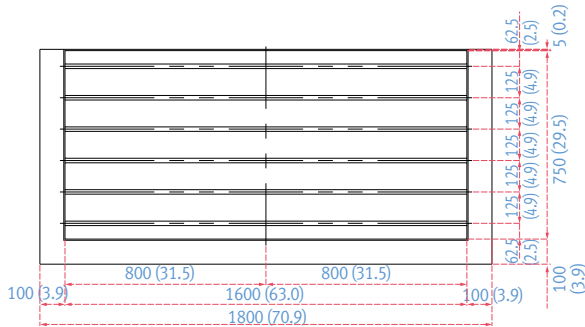

Mynx 9500

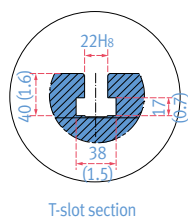
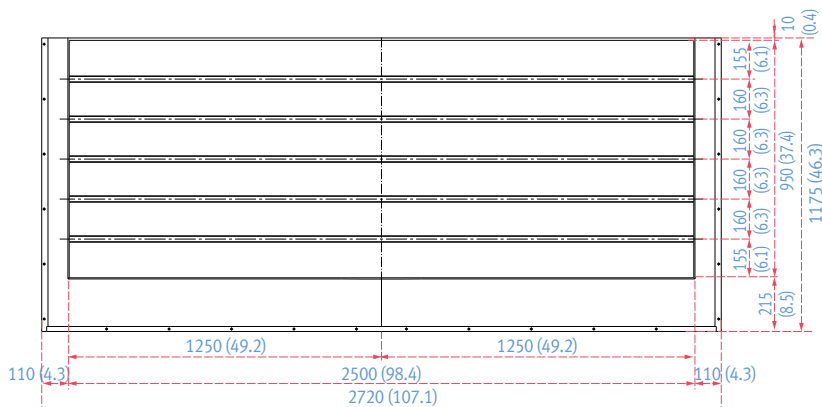

MACHINE SPECIFICATIONS

Description		Unit	Mynx 5400 II	Mynx 5400/50 II	Mynx 6500 II	Mynx 6500/50 II	Mynx 7500 II	Mynx 7500/50 II	Mynx 9500	
Travels	Travel distance	X axis	1020 (40.2)		1270 (50.0)		1525 (60.0)		2500 (98.4)	
		Y axis	550 (21.7)		670 (26.4)		770 (30.3)		950 (37.4)	
		Z axis	530 (20.9)		625 (24.6)		625 (24.6)		850 (33.5)	
	Distance from spindle nose to table top	mm (inch)	150 ~ 680 (5.9~26.8)	200 ~ 730 (7.9~28.7)	150 ~ 775 (5.9~30.5)	200 ~ 825 (7.9~32.4)	150 ~ 775 (5.9~30.5)	200 ~ 825 (7.9~32.4)	200 ~ 1000 (7.9~39.4)	
Table	Table size	mm (inch)	1200 x 540 (47.2 x 21.3)		1400 x 670 (55.1 x 26.4)		1600 x 750 (63.0 x 29.5)		2500 x 950 (98.4 x 37.4)	
	Table loading capacity	kW (Hp)	1000 (1341.0)		1300 (1743.3)		1500 (2011.5)		3500 (4693.5)	
	Table surface type	mm	T-SLOT (4-125 x 18H8)		T-SLOT (5-125 x 18H8)		T-SLOT (6-125 x 18H8)		T-SLOT (5-160 x 22H8)	
Spindle	Max. spindle speed	Direct	r/min	8000 {12000}	-	8000 {12000}	-	8000 {12000}	-	-
		Belt	r/min	-	6000 {6000}{8000}	-	6000 {6000}{8000}	-	6000 {6000}{8000}	-
		Gear	r/min	-	{6000}	-	{6000}	-	{6000}	6000
		Built in	r/min	-	-	-	-	-	-	{10000}
	Taper	-	ISO #40	ISO #50	ISO #40	ISO #50	ISO #40	ISO #50	ISO #50	
	Spindle power	Direct	kW (Hp)	15/11 {15.6} (20.1/14.8 {20.9})	-	15/11 {15.6} (20.1/14.8 {20.9})	-	15/11 {15.6} (20.1/14.8 {20.9})	-	-
		Belt	kW (Hp)	-	15/11 {18.5/15}{15/11} (20.1/14.8 {24.8/20.1} {20.1/14.8})	-	20/18.5 {18.5/18.5}{15/11} (26.8/24.8 {24.8/24.8} {20.1/14.8})	-	18.5/15 {22/18.5}{15/11} (24.8/18.5 {29.5/24.8} {20.1/14.8})	-
		Gear	kW (Hp)	-	{30/18.5} (40.2/24.8)	-	{30/18.5} (40.2/24.8)	-	{30/18.5} (40.2/24.8)	30/18.5 (40.2/24.8)
		Built in	kW (Hp)	-	-	-	-	-	-	{30/25} (40.2/33.5)
	Max. spindle torque	Direct	N·m (ft-lbs)	286.5 {165.5} (211.4 {122.1})	-	286.5 {165.5} (211.4 {122.1})	-	286.5 {165.5} (211.4 {122.1})	-	-
		Belt	N·m (ft-lbs)	-	286.4 {307.2}{286.4} (211.4 {226.7}{211.4})	-	286.4 {307.2}{286.4} (211.4 {226.7}{211.4})	-	307.2 {365.5}{286.4} (226.7 {269.7}{211.4})	-
		Gear	N·m (ft-lbs)	-	{617.4} {455.6}	-	{617.4} {455.6}	-	{617.4} {455.6}	617.4 (455.6)
		Built in	N·m (ft-lbs)	-	-	-	-	-	-	{420} {310.0}
	Feedrates	Rapid traverse rate	X axis	N·m (ft-lbs)		30 (22.1)		16 (11.8)		
			Y axis	N·m (ft-lbs)		30 (22.1)		16 (11.8)		
			Z axis	N·m (ft-lbs)		24 (17.7)		16 (11.8)		
Automatic Tool Changer	Rapid traverse rate	Tool shank	-	BT 40 {CAT40/DIN40}	BT 50 {CAT50/DIN50}	BT 40 {CAT40/DIN40}	BT 50 {CAT50/DIN50}	BT 40 {CAT40/DIN40}	BT 50 {CAT50/DIN50}	BT 50 {CAT50/DIN50}
		Pull stud	-	PS806	P50T-1 45deg	PS806	P50T-1 45deg	PS806	P50T-1 45deg	P50T-1 45deg
	Tool storage capa.	ea	30 {40}	24	30 {40}	24 {30}	30 {40}	24 {40}	30 {40}	
	Max. tool diameter	Continuous	mm (inch)	80 {76} (3.1 {3.0})	125 (4.9)	80 {76} (3.1 {3.0})	125 (4.9)	80 {76} (3.1 {3.0})	125 (4.9)	125 (4.9)
		Without Adjacent Tools	mm (inch)	125 (4.9)	220 (8.7)	125 (4.9)	220 (8.7)	125 (4.9)	220 (8.7)	220 (8.7)
	Max. tool length	mm (inch)	300 (11.8)	350 (13.8)	300 (11.8)	350 (13.8)	300 (11.8)	350 (13.8)	350 (13.8)	
	Max. tool weight	kg (lb)	8 (17.6)	20 (44.1)	8 (17.6)	20 (44.1)	8 (17.6)	20 (44.1)	20 (44.1)	
	Max. tool moment	N·m (ft-lbs)	5.88 (4.3)	22 (16.2)	5.88 (4.3)	22 (16.2)	5.88 (4.3)	22 (16.2)	22 (16.2)	
	Tool selection		MEMORY RANDOM							
	Tool change time (Tool-to-tool)	sec	1.3	2.5	1.3	2.5	1.3	2.5	2.5	
Tool change time (Chip-to-chip)	sec	3.7	5.5	3.7	5.5	3.7	5.5	6.67		
Power source	Electric power supply (rated capacity)	Direct	kVA	32.2 {44.4}	-	35.1 {47.3}	-	38.5 {50.7}	-	-
		Belt	kVA	-	36.1 {36.1} {40}	-	39.4 {44.6} {48.4}	-	47.3 {51.8} {42.9}	-
		Gear	kVA	-	{47.7}	-	{48.4}	-	{51.8}	47.0
		Built in	kVA	-	-	-	-	-	-	{54.2}
	Compressed air supply	Mpa	0.54							
Tank capacity	Coolant tank capacity	L	420			470			500	
Machine Dimensions	Height	mm (inch)	F_3012 (118.6) H/S_3117 (122.7)	2920 (115.0)	F_3107 (122.3) H/S_3216 (126.6)	3016 (118.7)	F_3227 (127.0) H/S_3337 (131.4)	3292 (129.6)	3598 (141.7)	
	Length	mm (inch)	2467 (97.1)	2467 (97.1)	2692 (106.0)	2692 (106.0)	3900 (153.5)	3900 (153.5)	4315 (169.9)	
	Width	mm (inch)	3350 (131.9)	3350 (131.9)	3350 (131.9)	3350 (131.9)	4050 (159.4)	4050 (159.4)	6480 (255.1)	
	Weight	kg (lb)	7000 (15432.1)	7500 (16534.4)	9000 (19841.3)	9500 (20943.6)	13500 (29762.0)	13500 (29762.0)	23000 (50705.6)	
Control	NC system	-	DN Solutions Fanuc i Plus, Fanuc 32i {SIEMENS S828D / HEIDENHAIN TNC 620}							



dn-solutions.com

Head Office

22F T Tower, 30, Sowol-ro 2-gil
Jung-gu, Seoul, Korea, 04637

Tel: +82-2-6972-0370/0350
Fax: +82-2-6972-0400

DN Solutions America

19A Chapin Road, Pine Brook
New Jersey 07058, United States

Tel: +1-973-618-2500
Fax: +1-973-618-2501

DN Solutions Europe

Emdener Strasse 24, D-41540
Dormagen, Germany

Tel: +49-2133-5067-100
Fax: +49-2133-5067-111

DN Solutions India

No.82, Jakkuar Village
Yelahanka Hobli, Bangalore-560064

Tel: + 91-80-2205-6900
E-mail: india@dncompany.com

DN Solutions China

Room 101,201,301, Building 39 Xinzhuan
Highway No.258 Songjiang District
China Shanghai (201612)

Tel: +86 21-5445-1155
Fax: +86 21-6405-1472

Sales inquiry

sales@dncompany.com

* For more details, please contact DN Solutions.

* Specifications and information contained within this catalogue may be changed without prior notice.